

## Area of a circle

### Grade 5 Geometry Worksheet

---

Calculate the area of each circle.

1)

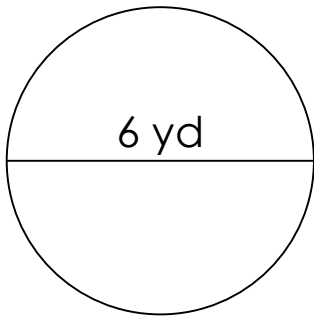

2)

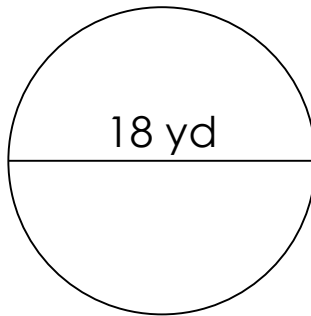

3)

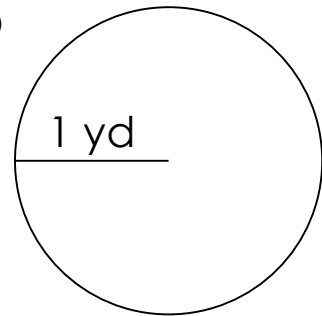

4)

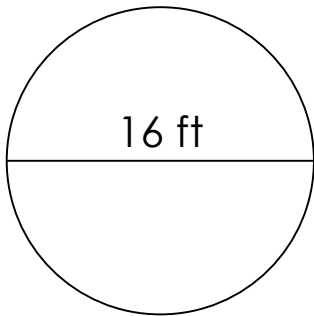

5)

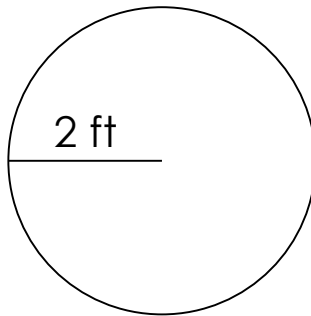

6)

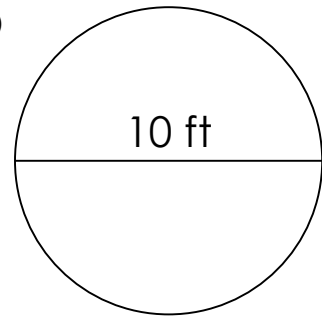

7)

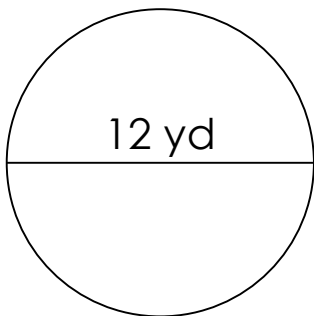

8)

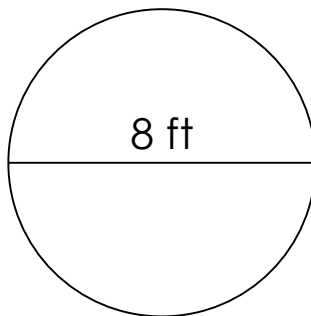

9)

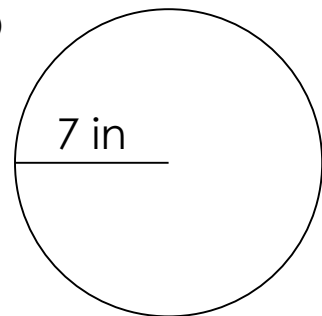

## Area of a circle

### Grade 5 Geometry Worksheet

---

Calculate the area of each circle.

